

HIGHLIGHTS OF PRESCRIBING INFORMATION

These highlights do not include all the information needed to use BEVESPI AEROSPHERE safely and effectively. See full prescribing information for BEVESPI AEROSPHERE.

BEVESPI AEROSPHERE™ (glycopyrrolate and formoterol fumarate) inhalation aerosol, for oral inhalation use
Initial U.S. Approval: 2016

WARNING: ASTHMA-RELATED DEATH
See full prescribing information for complete boxed warning.

- Long-acting beta₂-adrenergic agonists (LABAs), such as formoterol fumarate, one of the active ingredients in BEVESPI AEROSPHERE, increase the risk of asthma-related death. A placebo-controlled trial with another LABA (salmeterol) showed an increase in asthma-related deaths in subjects receiving salmeterol. This finding with salmeterol is considered a class effect of all LABAs, including formoterol fumarate. (5.1)
- The safety and efficacy of BEVESPI AEROSPHERE in patients with asthma have not been established. BEVESPI AEROSPHERE is not indicated for the treatment of asthma. (5.1)

- Do not initiate in acutely deteriorating COPD or to treat acute symptoms. (5.2)
- Do not use in combination with an additional medicine containing a LABA because of risk of overdose. (5.3, 7.1)
- If paradoxical bronchospasm occurs, discontinue BEVESPI AEROSPHERE and institute alternative therapy. (5.4)
- Use with caution in patients with cardiovascular disorders. (5.6)
- Use with caution in patients with convulsive disorders, thyrotoxicosis, diabetes mellitus, and ketoacidosis. (5.7)
- Be alert to hypokalemia and hyperglycemia. (5.8)
- Worsening of narrow-angle glaucoma may occur. Use with caution in patients with narrow-angle glaucoma and instruct patients to contact a physician immediately if symptoms occur. (5.9)
- Worsening urinary retention may occur. Use with caution in patients with prostatic hyperplasia or bladder-neck obstruction and instruct patients to contact a physician immediately if symptoms occur. (5.10)

-----INDICATIONS AND USAGE-----

BEVESPI AEROSPHERE is a combination of glycopyrrolate, an anticholinergic, and formoterol fumarate, a long-acting beta₂-adrenergic agonist (LABA) indicated for the long-term, maintenance treatment of airflow obstruction in patients with chronic obstructive pulmonary disease (COPD). (1)

Limitation of Use: Not indicated for the relief of acute bronchospasm or for the treatment of asthma. (1, 5.1, 5.2)

-----DOSAGE AND ADMINISTRATION-----

- For oral inhalation only.
- Maintenance treatment of COPD: 2 inhalations of BEVESPI AEROSPHERE twice daily. (2)

-----DOSAGE FORMS AND STRENGTHS-----

- Inhalation aerosol: Pressurized metered dose inhaler containing a combination of glycopyrrolate (9 mcg) and formoterol fumarate (4.8 mcg) as an inhalation aerosol.
- Two inhalations equal one dose. (3)

-----CONTRAINDICATIONS-----

- All LABAs are contraindicated in patients with asthma without use of a long-term asthma controller medication. (4) BEVESPI AEROSPHERE is not indicated for the treatment of asthma. (1)
- Hypersensitivity to glycopyrrolate, formoterol fumarate, or to any component of this product. (4, 5.5)

-----WARNINGS AND PRECAUTIONS-----

-----ADVERSE REACTIONS-----

Most common adverse reactions (incidence ≥2% and more common than with placebo) include: urinary tract infection and cough. (6.1)

To report SUSPECTED ADVERSE REACTIONS, contact AstraZeneca at 1-800-236-9933 or FDA at 1-800-FDA-1088 or www.fda.gov/medwatch.

-----DRUG INTERACTIONS-----

- Other adrenergic drugs may potentiate effect: Use with caution (5.3, 7.1)
- Xanthine derivatives, steroids, diuretics or non-potassium sparing diuretics may potentiate hypokalemia or ECG changes. Use with caution. (7.2, 7.3)
- Diuretics: Use with caution. Electrocardiographic changes and/or hypokalemia associated with non-potassium sparing diuretics may worsen with concomitant beta₂-agonists. (7.3)
- Monoamine oxidase inhibitors and tricyclic antidepressants: Use with extreme caution. May potentiate effect of formoterol fumarate on cardiovascular system. (7.4)
- Beta-blockers: Use with caution and only when medically necessary. (7.5)
- Anticholinergics: May interact additively with concomitantly used anticholinergic medications. Avoid administrations of BEVESPI AEROSPHERE with other anticholinergic-containing drugs. (7.6)

-----USE IN SPECIFIC POPULATIONS-----

- Use in patients with severe renal impairment should be considered if the potential benefit of the treatment outweighs the risk. (8.7)

See 17 for PATIENT COUNSELING INFORMATION and Medication Guide

Revised: 4/2016

FULL PRESCRIBING INFORMATION: CONTENTS*

WARNING: ASTHMA-RELATED DEATH..... 3

1 INDICATIONS AND USAGE..... 3

2 DOSAGE AND ADMINISTRATION..... 3

3 DOSAGE FORMS AND STRENGTHS..... 4

4 CONTRAINDICATIONS..... 4

5 WARNINGS AND PRECAUTIONS 4

 5.1. Asthma-Related Death..... 4

 5.2. Deterioration of Disease and Acute Episodes 4

 5.3. Excessive Use of BEVESPI and Use with Other Long-Acting Beta₂-Agonists..... 5

 5.4. Paradoxical Bronchospasm 5

5.5. Hypersensitivity Reactions 5

5.6. Cardiovascular Effects 6

5.7. Coexisting Conditions..... 6

5.8. Hypokalemia and Hyperglycemia 6

5.9. Worsening of Narrow-Angle Glaucoma 6

5.10. Worsening of Urinary Retention 6

6 ADVERSE REACTIONS 7

6.1. Clinical Trials Experience 7

7 DRUG INTERACTIONS 8

7.1. Adrenergic Drugs 8

7.2. Xanthine Derivatives, Steroids, or Diuretics..... 9

7.3. Non-Potassium Sparing Diuretics..... 9

7.4.	Monoamine Oxidase Inhibitors, Tricyclic Antidepressants, QTc Prolonging Drugs.....	9
7.5.	Beta-Blockers	9
7.6.	Anticholinergics.....	9
8	USE IN SPECIFIC POPULATIONS.....	10
8.1.	Pregnancy	10
8.2.	Labor and Delivery.....	10
8.3.	Nursing Mothers	11
8.4.	Pediatric Use	11
8.5.	Geriatric Use.....	11
8.6.	Hepatic Impairment.....	11
8.7.	Renal Impairment.....	11
10	OVERDOSAGE.....	11
11	DESCRIPTION.....	12

12	CLINICAL PHARMACOLOGY	14
12.1.	Mechanism of Action	14
12.2.	Pharmacodynamics	15
12.3.	Pharmacokinetics	15
13	NONCLINICAL TOXICOLOGY	17
13.1.	Carcinogenesis, Mutagenesis, Impairment of Fertility ..	17
14	CLINICAL STUDIES	18
14.1.	Dose-Ranging Trials.....	18
14.2.	Confirmatory Trials	20
16	HOW SUPPLIED/STORAGE AND HANDLING	23
17	PATIENT COUNSELING INFORMATION	24

*Sections or subsections omitted from the full prescribing information are not listed.

FULL PRESCRIBING INFORMATION

WARNING: ASTHMA-RELATED DEATH

Long-acting beta₂-adrenergic agonists (LABAs) increase the risk of asthma-related death. Data from a large placebo-controlled US trial that compared the safety of another LABA (salmeterol) with placebo added to usual asthma therapy showed an increase in asthma-related deaths in subjects receiving salmeterol. This finding with salmeterol is considered a class effect of all LABAs, including formoterol fumarate, one of the active ingredients in BEVESPI AEROSPHERE.

The safety and efficacy of BEVESPI AEROSPHERE in patients with asthma have not been established. BEVESPI AEROSPHERE is not indicated for the treatment of asthma. [see Warnings and Precautions (5.1)]

1 INDICATIONS AND USAGE

BEVESPI AEROSPHERE is a combination of glycopyrrolate and formoterol fumarate indicated for the long-term, maintenance treatment of airflow obstruction in patients with chronic obstructive pulmonary disease (COPD), including chronic bronchitis and/or emphysema.

Important Limitation of Use: BEVESPI AEROSPHERE is not indicated for the relief of acute bronchospasm or for the treatment of asthma [see Warnings and Precautions (5.1, 5.2)].

2 DOSAGE AND ADMINISTRATION

BEVESPI AEROSPHERE (glycopyrrolate/formoterol fumarate 9 mcg/4.8 mcg) should be administered as two inhalations taken twice daily in the morning and in the evening by the orally inhaled route only. Do not take more than two inhalations twice daily.

BEVESPI AEROSPHERE contains 120 inhalations per canister. The canister has an attached dose indicator, which indicates how many inhalations remain. The dose indicator display will move after every tenth actuation. When nearing the end of the usable inhalations, the color behind the number in the dose indicator display window changes to red. BEVESPI AEROSPHERE should be discarded when the dose indicator display window shows zero.

Priming BEVESPI AEROSPHERE is essential to ensure appropriate drug content in each actuation. Prime BEVESPI AEROSPHERE before using for the first time. To prime BEVESPI AEROSPHERE, release 4 sprays into the air away from the face, shaking well before each spray. BEVESPI AEROSPHERE must be re-primed when the inhaler has not been used for more than 7 days. To re-prime BEVESPI AEROSPHERE, release 2 sprays into the air away from the face, shaking well before each spray.

3 DOSAGE FORMS AND STRENGTHS

Inhalation Aerosol: BEVESPI AEROSPHERE is a pressurized metered dose inhaler that delivers 9 mcg of glycopyrrolate and 4.8 mcg of formoterol fumarate per inhalation. Two inhalations equal one dose. BEVESPI AEROSPHERE contains 120 inhalations per canister. The canister has an attached dose indicator and is supplied with a white plastic actuator with an orange dust cap.

4 CONTRAINDICATIONS

All LABAs are contraindicated in patients with asthma without use of a long-term asthma control medication [*see Warnings and Precautions (5.1)*]. BEVESPI AEROSPHERE is not indicated for the treatment of asthma.

BEVESPI AEROSPHERE is contraindicated in patients with hypersensitivity to glycopyrrolate, formoterol fumarate, or to any component of the product [*see Warnings and Precautions (5.5)*].

5 WARNINGS AND PRECAUTIONS

5.1. Asthma-Related Death

- Data from a large placebo-controlled trial in subjects with asthma showed that LABAs may increase the risk of asthma-related death. Data are not available to determine whether the rate of death in patients with COPD is increased by LABAs.
- A 28-week, placebo-controlled US trial comparing the safety of another LABA (salmeterol) with placebo, each added to usual asthma therapy, showed an increase in asthma-related deaths in subjects receiving salmeterol (13/13,176 in subjects treated with salmeterol vs. 3/13,179 in subjects treated with placebo; RR 4.37, 95% CI: 1.25, 15.34). The increased risk of asthma-related death is considered a class effect of LABAs, including formoterol fumarate, one of the active ingredients in BEVESPI AEROSPHERE.
- No trial adequate to determine whether the rate of asthma-related deaths is increased in patients treated with BEVESPI AEROSPHERE has been conducted. The safety and efficacy of BEVESPI AEROSPHERE in patients with asthma have not been established. BEVESPI AEROSPHERE is not indicated for the treatment of asthma.

5.2. Deterioration of Disease and Acute Episodes

BEVESPI AEROSPHERE should not be initiated in patients with acutely deteriorating COPD, which may be a life-threatening condition. BEVESPI AEROSPHERE has not been studied in patients with acutely deteriorating COPD. The use of BEVESPI AEROSPHERE in this setting is inappropriate.

BEVESPI AEROSPHERE should not be used for the relief of acute symptoms, i.e., as rescue therapy for the treatment of acute episodes of bronchospasm. BEVESPI AEROSPHERE has

not been studied in the relief of acute symptoms and extra doses should not be used for that purpose. Acute symptoms should be treated with an inhaled short-acting beta₂-agonist.

When beginning BEVESPI AEROSPHERE, patients who have been taking inhaled, short-acting beta₂-agonists on a regular basis (e.g., four times a day) should be instructed to discontinue the regular use of these medicines and use them only for symptomatic relief of acute respiratory symptoms. When prescribing BEVESPI AEROSPHERE, the healthcare provider should also prescribe an inhaled, short acting beta₂-agonist and instruct the patient on how it should be used. Increasing inhaled beta₂-agonist use is a signal of deteriorating disease for which prompt medical attention is indicated.

COPD may deteriorate acutely over a period of hours or chronically over several days or longer. If BEVESPI AEROSPHERE no longer controls the symptoms of bronchoconstriction, or the patient's inhaled, short-acting beta₂-agonist becomes less effective, or the patient needs more inhalations of short-acting beta₂-agonist than usual, these may be markers of deterioration of disease. In this setting, a re-evaluation of the patient and the COPD treatment regimen should be undertaken at once. Increasing the daily dosage of BEVESPI AEROSPHERE beyond the recommended dose is not appropriate in this situation.

5.3. Excessive Use of BEVESPI and Use with Other Long-Acting Beta₂-Agonists

As with other inhaled medicines containing beta₂-agonists, BEVESPI AEROSPHERE should not be used more often than recommended, at higher doses than recommended, or in conjunction with other medications containing LABAs, as an overdose may result. Clinically significant cardiovascular effects and fatalities have been reported in association with excessive use of inhaled sympathomimetic medicines. Patients using BEVESPI AEROSPHERE should not use another medicine containing a LABA for any reason [*see Drug Interactions (7.1)*].

5.4. Paradoxical Bronchospasm

As with other inhaled medicines, BEVESPI AEROSPHERE can produce paradoxical bronchospasm, which may be life threatening. If paradoxical bronchospasm occurs following dosing with BEVESPI AEROSPHERE, it should be treated immediately with an inhaled, short-acting bronchodilator, BEVESPI AEROSPHERE should be discontinued immediately, and alternative therapy should be instituted.

5.5. Immediate Hypersensitivity Reactions

Immediate hypersensitivity reactions have been reported after administration of glycopyrrolate or formoterol fumarate, the components of BEVESPI AEROSPHERE. If signs suggesting allergic reactions occur, in particular, angioedema (including difficulties in breathing or swallowing, swelling of tongue, lips and face), urticaria, or skin rash, BEVESPI AEROSPHERE should be stopped at once and alternative treatment should be considered.

5.6. Cardiovascular Effects

Formoterol fumarate, like other beta₂-agonists, can produce a clinically significant cardiovascular effect in some patients as measured by increases in pulse rate, systolic or diastolic blood pressure, or symptoms [see *Clinical Pharmacology (12.2)*]. If such effects occur, BEVESPI AEROSPHERE may need to be discontinued. In addition, beta-agonists have been reported to produce electrocardiographic changes, such as flattening of the T wave, prolongation of the QTc interval, and ST segment depression, although the clinical significance of these findings is unknown.

Therefore, BEVESPI AEROSPHERE should be used with caution in patients with cardiovascular disorders, especially coronary insufficiency, cardiac arrhythmias, and hypertension.

5.7. Coexisting Conditions

BEVESPI AEROSPHERE, like all medications containing sympathomimetic amines, should be used with caution in patients with convulsive disorders or thyrotoxicosis and in those who are unusually responsive to sympathomimetic amines. Doses of the related beta₂-agonist albuterol, when administered intravenously, have been reported to aggravate pre-existing diabetes mellitus and ketoacidosis.

5.8. Hypokalemia and Hyperglycemia

Beta₂-agonist medications may produce significant hypokalemia in some patients, possibly through intracellular shunting, which has the potential to produce adverse cardiovascular effects [see *Clinical Pharmacology (12.2)*]. The decrease in serum potassium is usually transient, not requiring supplementation. Beta₂-agonist medicines may produce transient hyperglycemia in some patients. In two clinical trials of 24-weeks and a 28-week safety extension study evaluating BEVESPI AEROSPHERE in subjects with COPD, there was no evidence of a treatment effect on serum glucose or potassium.

5.9. Worsening of Narrow-Angle Glaucoma

BEVESPI AEROSPHERE should be used with caution in patients with narrow-angle glaucoma. Prescribers and patients should be alert for signs and symptoms of acute narrow-angle glaucoma (e.g., eye pain or discomfort, blurred vision, visual halos or colored images in association with red eyes from conjunctival congestion and corneal edema). Instruct patients to consult a physician immediately should any of these signs or symptoms develop.

5.10. Worsening of Urinary Retention

BEVESPI AEROSPHERE should be used with caution in patients with urinary retention. Prescribers and patients should be alert for signs and symptoms of urinary retention (e.g., difficulty passing urine, painful urination), especially in patients with prostatic hyperplasia or bladder-neck obstruction. Instruct patients to consult a physician immediately should any of these signs or symptoms develop.

6 ADVERSE REACTIONS

LABAs, such as formoterol fumarate, one of the active ingredients in BEVESPI AEROSPHERE, increase the risk of asthma-related death. BEVESPI AEROSPHERE is not indicated for the treatment of asthma [see *Boxed Warning and Warnings and Precautions (5.1)*].

The following adverse reactions are described in greater detail elsewhere in the labeling:

- Paradoxical bronchospasm [see *Warnings and Precautions (5.4)*]
- Hypersensitivity reactions [see *Contraindications (4), Warnings and Precautions (5.5)*]
- Cardiovascular effects [see *Warnings and Precautions (5.6)*]
- Worsening of narrow-angle glaucoma [see *Warnings and Precautions (5.9)*]
- Worsening of urinary retention [see *Warnings and Precautions (5.10)*]

6.1. Clinical Trials Experience

Because clinical trials are conducted under widely varying conditions, adverse reaction rates observed in the clinical trials of a drug cannot be directly compared with rates in the clinical trials of another drug and may not reflect the rates observed in practice.

The clinical program for BEVESPI AEROSPHERE included 4,911 subjects with COPD in two 24-week lung function trials, one long-term safety extension study of 28 weeks, and 10 other trials of shorter duration. A total of 1,302 subjects have received at least 1 dose of BEVESPI AEROSPHERE. The safety data described below are based on the two 24-week trials and the one 28-week long-term safety extension trial. Adverse reactions observed in the other trials were similar to those observed in these confirmatory trials.

24-Week Trials

The incidence of adverse reactions with BEVESPI AEROSPHERE in Table 1 is based on reports in two 24-week, placebo-controlled trials (Trials 1 and 2; n=2,100 and n=1,610, respectively). Of the 3,710 subjects, 56% were male and 91% were Caucasian. They had a mean age of 63 years and an average smoking history of 51 pack-years, with 54% identified as current smokers. At screening, the mean post-bronchodilator percent predicted forced expiratory volume in 1 second (FEV₁) was 51% (range: 19% to 82%) and the mean percent reversibility was 20% (range: -32% to 135%).

Subjects received one of the following treatments: BEVESPI AEROSPHERE, glycopyrrolate 18 mcg, formoterol fumarate 9.6 mcg, or placebo twice daily or active control.

Table 1 - Adverse Reactions with BEVESPI AEROSPHERE \geq 2% Incidence and More Common than with Placebo in Subjects with Chronic Obstructive Pulmonary Disease

Adverse Reaction	BEVESPI AEROSPHERE (n=1036) %	Glycopyrrolate 18 mcg BID (n=890) %	Formoterol Fumarate 9.6 mcg BID (n=890) %	Placebo (n=443) %
Respiratory, thoracic, and mediastinal disorders				
Cough	4.0	3.0	2.7	2.7
Infections and infestation				
Urinary tract infection	2.6	1.8	1.5	2.3

Other adverse reactions defined as events with an incidence of $>1\%$ but less than 2% with BEVESPI AEROSPHERE but more common than with placebo included the following: arthralgia, chest pain, tooth abscess, muscle spasms, headache, oropharyngeal pain, vomiting, pain in extremity, dizziness, anxiety, dry mouth, fall, influenza, fatigue, acute sinusitis, and contusion.

Long-Term Safety Extension Trial

In a 28-week long-term safety extension trial, 893 subjects who successfully completed Trial 1 or Trial 2 were treated for up to an additional 28 weeks for a total treatment period of up to 52 weeks with BEVESPI AEROSPHERE, glycopyrrolate 18 mcg, formoterol fumarate 9.6 mcg administered twice daily or active control. Because the subjects continued from Trial 1 or Trial 2 into the safety extension trial, the demographic and baseline characteristics of the long-term safety extension trial were similar to those of the placebo-controlled efficacy trials described above. The adverse reactions reported in the long-term safety trial were consistent with those observed in the 24-week placebo-controlled trials.

Additional Adverse Reactions: Other adverse reactions that have been associated with the component formoterol fumarate include: hypersensitivity reactions, hyperglycemia, sleep disturbance, agitation, restlessness, tremor, nausea, tachycardia, palpitations, cardiac arrhythmias (atrial fibrillation, supraventricular tachycardia, and extrasystoles).

7 DRUG INTERACTIONS

No formal drug interaction studies have been performed with BEVESPI AEROSPHERE.

7.1. Adrenergic Drugs

If additional adrenergic drugs are to be administered by any route, they should be used with caution because the sympathetic effects of formoterol, a component of BEVESPI AEROSPHERE, may be potentiated [*see Warnings and Precautions (5.3)*].

7.2. Xanthine Derivatives, Steroids, or Diuretics

Concomitant treatment with xanthine derivatives, steroids, or diuretics may potentiate any hypokalemic effect of beta₂ adrenergic agonists such as formoterol, a component of BEVESPI AEROSPHERE.

7.3. Non-Potassium Sparing Diuretics

The ECG changes and/or hypokalemia that may result from the administration of non-potassium-sparing diuretics (such as loop or thiazide diuretics) can be acutely worsened by beta₂-agonists, especially when the recommended dose of the beta₂-agonist is exceeded. Approximately 17% of subjects were taking non-potassium sparing diuretics during the two 24-week placebo-controlled trials in subjects with COPD. The incidence of adverse events in subjects taking non-potassium-sparing diuretics was similar between BEVESPI AEROSPHERE and placebo treatment groups. In addition, there was no evidence of a treatment effect on serum potassium with BEVESPI AEROSPHERE compared to placebo in subjects taking non-potassium sparing diuretics during the two 24-week trials. However, caution is advised in the coadministration of BEVESPI AEROSPHERE with non-potassium-sparing diuretics.

7.4. Monoamine Oxidase Inhibitors, Tricyclic Antidepressants, QTc Prolonging Drugs

BEVESPI AEROSPHERE, as with other beta₂-agonists, should be administered with extreme caution to patients being treated with monoamine oxidase inhibitors or tricyclic antidepressants or other drugs known to prolong the QTc interval because the action of adrenergic agonists on the cardiovascular system may be potentiated by these agents. Drugs that are known to prolong the QTc interval may be associated with an increased risk of ventricular arrhythmias.

7.5. Beta-Blockers

Beta-adrenergic receptor antagonists (beta-blockers) and BEVESPI AEROSPHERE may interfere with the effect of each other when administered concurrently. Beta-blockers not only block the therapeutic effects of beta₂-agonists, but may produce severe bronchospasm in COPD patients. Therefore, patients with COPD should not normally be treated with beta-blockers. However, under certain circumstances, e.g., as prophylaxis after myocardial infarction, there may be no acceptable alternatives to the use of beta-blockers in patients with COPD. In this setting, cardioselective beta-blockers could be considered, although they should be administered with caution.

7.6. Anticholinergics

There is a potential for an additive interaction with concomitantly used anticholinergic medications. Therefore, avoid coadministration of BEVESPI AEROSPHERE with other

anticholinergic-containing drugs as this may lead to an increase in anticholinergic adverse effects [see *Warnings and Precautions* (5.9, 5.10) and *Adverse Reactions* (6)].

8 USE IN SPECIFIC POPULATIONS

8.1. Pregnancy

Teratogenic Effects:

Pregnancy Category C. There are no adequate and well-controlled trials of BEVESPI AEROSPHERE or its individual components, glycopyrrolate and formoterol fumarate, in pregnant women. Because animal reproduction studies are not always predictive of human response, BEVESPI AEROSPHERE should be used during pregnancy only if the potential benefit justifies the potential risk to the fetus. Women should be advised to contact their physicians if they become pregnant while taking BEVESPI AEROSPHERE.

Glycopyrrolate: There was no evidence of teratogenic effects in rats and rabbits at approximately 18,000 and 270 times, respectively, the maximum recommended human daily inhalation dose (MRHDID) in adults (on a mg/m² basis at a maternal oral dose of 65 mg/kg/day in rats and at a maternal intramuscular injection dose of 0.5 mg/kg in rabbits).

Single-dose studies in humans found that very small amounts of glycopyrrolate passed the placental barrier.

Formoterol Fumarate: Formoterol fumarate has been shown to be teratogenic, embryocidal, to increase pup loss at birth and during lactation, and to decrease pup weights in rats and teratogenic in rabbits. These effects were observed at approximately 1,500 (rats) and 61,000 (rabbits) times the MRHDID (on a mg/m² basis at maternal oral doses of 3 mg/kg/day and above in rats and 60 mg/kg/day in rabbits). Umbilical hernia was observed in rat fetuses at approximately 1,500 times the MRHDID (on a mg/m² basis at maternal oral doses of 3 mg/kg/day and above). Prolonged pregnancy and fetal brachygnathia was observed in rats at approximately 7600 times the MRHDID (on a mg/m² basis at an oral maternal dose of 15 mg/kg/day in rats). In another study in rats, no teratogenic effects were seen at approximately 600 times the MRHDID (on a mg/m² basis at maternal inhalation doses up to 1.2 mg/kg/day in rats).

Subcapsular cysts on the liver were observed in rabbit fetuses at an oral dose approximately 61,000 times the MRHDID (on a mg/m² basis at a maternal oral dose of 60 mg/kg/day in rabbits). No teratogenic effects were observed at approximately 3600 times the MRHDID (on a mg/m² basis at maternal oral doses up to 3.5 mg/kg/day).

8.2. Labor and Delivery

There are no well-controlled human trials that have investigated the effects of BEVESPI AEROSPHERE on preterm labor or labor at term. Because beta₂-agonists may potentially interfere with uterine contractility, BEVESPI AEROSPHERE should be used during labor only if the potential benefit justifies the potential risk.

8.3. Nursing Mothers

It is not known whether BEVESPI AEROSPHERE is excreted in human milk. Because many drugs are excreted in human milk and because formoterol fumarate, one of the active ingredients in BEVESPI AEROSPHERE, has been detected in the milk of lactating rats, caution should be exercised when BEVESPI AEROSPHERE is administered to a nursing woman. Since there are no data from controlled trials on the use of BEVESPI AEROSPHERE by nursing mothers, a decision should be made whether to discontinue nursing or to discontinue BEVESPI AEROSPHERE, taking into account the importance of BEVESPI AEROSPHERE to the mother.

8.4. Pediatric Use

BEVESPI AEROSPHERE is not indicated for use in children. The safety and effectiveness of BEVESPI AEROSPHERE in the pediatric population have not been established.

8.5. Geriatric Use

Based on available data, no adjustment of the dosage of BEVESPI AEROSPHERE in geriatric patients is necessary, but greater sensitivity in some older individuals cannot be ruled out.

The confirmatory trials of BEVESPI AEROSPHERE for COPD included 1,680 subjects aged 65 and older and, of those, 290 subjects were aged 75 and older. No overall differences in safety or effectiveness were observed between these subjects and younger subjects.

8.6. Hepatic Impairment

Formal pharmacokinetic studies using BEVESPI AEROSPHERE have not been conducted in patients with hepatic impairment. However, since formoterol fumarate is predominantly cleared by hepatic metabolism, impairment of liver function may lead to accumulation of formoterol fumarate in plasma. Therefore, patients with hepatic disease should be closely monitored.

8.7. Renal Impairment

Formal pharmacokinetic studies using BEVESPI AEROSPHERE have not been conducted in patients with renal impairment. In patients with severe renal impairment (creatinine clearance of ≤ 30 mL/min/1.73 m²) or end-stage renal disease requiring dialysis, BEVESPI AEROSPHERE should be used if the expected benefit outweighs the potential risk [see Clinical Pharmacology (12.3)].

10 OVERDOSAGE

No cases of overdose have been reported with BEVESPI AEROSPHERE. BEVESPI AEROSPHERE contains both glycopyrrolate and formoterol fumarate; therefore, the risks associated with overdosage for the individual components described below apply to

BEVESPI AEROSPHERE. Treatment of overdose consists of discontinuation of BEVESPI AEROSPHERE together with institution of appropriate symptomatic and/or supportive therapy. The judicious use of a cardioselective beta-receptor blocker may be considered, bearing in mind that such medication can produce bronchospasm. Cardiac monitoring is recommended in case of overdose.

Glycopyrrolate

High doses of glycopyrrolate, a component of BEVESPI AEROSPHERE, may lead to anticholinergic signs and symptoms such as nausea, vomiting, dizziness, lightheadedness, blurred vision, increased intraocular pressure (causing pain, vision disturbances or reddening of the eye), obstipation or difficulties in voiding. However, there were no systemic anticholinergic adverse effects following single inhaled doses up to 144 mcg in subjects with COPD.

Formoterol Fumarate

An overdose of formoterol fumarate would likely lead to an exaggeration of effects that are typical for beta₂-agonists: seizures, angina, hypertension, hypotension, tachycardia, atrial and ventricular tachyarrhythmias, nervousness, headache, tremor, palpitations, muscle cramps, nausea, dizziness, sleep disturbances, metabolic acidosis, hyperglycemia, hypokalemia. As with all sympathomimetic medications, cardiac arrest and even death may be associated with abuse of formoterol fumarate.

11 DESCRIPTION

BEVESPI AEROSPHERE (glycopyrrolate and formoterol fumarate) Inhalation Aerosol is a pressurized metered-dose inhaler that contains a combination of micronized glycopyrrolate, an anticholinergic, and micronized formoterol fumarate, a long-acting beta₂-adrenergic agonist, for oral inhalation.

Glycopyrrolate is a quaternary ammonium salt with the following chemical name: (*RS*)-[3-(*SR*)-Hydroxy-1,1-dimethylpyrrolidinium bromide] α -cyclopentylmandelate. Glycopyrrolate is a powder that is freely soluble in water. The molecular formula is C₁₉H₂₈BrNO₃⁻, and the molecular weight is 398.33 g/mol. The structural formula is as follows:

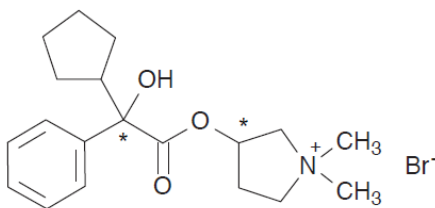

Glycopyrrolate contains two chiral centers (denoted by * in structure above) and is a racemate of a 1:1 mixture of the R,S and S,R diastereomers. The active moiety, glycopyrrolonium, is the positively charged ion of glycopyrrolate.

Formoterol fumarate has the chemical name *N*-[2-Hydroxy-5-[(1*R*S)-1-hydroxy-2-[[*(1R*S)-2-(4-methoxyphenyl)-1-methylethyl]-amino] ethyl]phenyl] formamide, (*E*)-2-butenedioate dihydrate. Formoterol fumarate is a powder that is slightly soluble in water. The molecular formula is $(C_{19}H_{24}N_2O_4)_2 \cdot C_4H_4O_4 \cdot 2H_2O$ and the molecular weight is 840.91 g/mol. The structural formula is as follows:

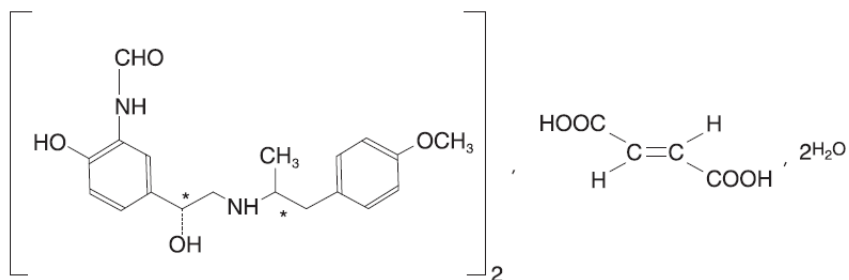

Formoterol fumarate contains two chiral centers (denoted by * in structure above), and consists of a single enantiomeric pair (a racemate of R,R and S,S).

BEVESPI AEROSPHERE is formulated as a hydrofluoroalkane (HFA 134a) propelled pressurized metered dose inhaler containing 120 inhalations. The canister has an attached dose indicator and is supplied with a white plastic actuator body and mouthpiece with an orange dust cap.

After priming each actuation of the inhaler meters 10.4 mcg of glycopyrrolate (equivalent to 8.3 mcg of glycopyrronium) and 5.5 mcg of formoterol fumarate from the valve which delivers 9 mcg of glycopyrrolate (equivalent to 7.2 mcg of glycopyrronium) and 4.8 mcg of formoterol fumarate from the actuator. The actual amount of drug delivered to the lung may depend on patient factors, such as the coordination between actuation of the device and inspiration through the delivery system. BEVESPI AEROSPHERE also contains porous particles that form a cosuspension with the drug crystals. The porous particles are comprised of the phospholipid, 1,2-Distearoyl-*sn*-glycero-3-phosphocholine (DSPC), and calcium chloride. Porous particles and HFA 134a are excipients in the formulation.

Priming BEVESPI AEROSPHERE is essential to ensure appropriate drug content in each actuation. Prime BEVESPI AEROSPHERE before using for the first time. To prime BEVESPI AEROSPHERE, release 4 sprays into the air away from the face, shaking well before each spray.

If the product is not used for more than 7 days re-prime the device. To re-prime BEVESPI AEROSPHERE, release 2 sprays into the air away from the face, shaking well before each spray.

12 CLINICAL PHARMACOLOGY

12.1. Mechanism of Action

BEVESPI AEROSPHERE

BEVESPI AEROSPHERE contains both glycopyrrolate and formoterol fumarate. The mechanism of action described below for the individual components apply to BEVESPI AEROSPHERE. These drugs represent two different classes of medications (a long-acting muscarinic antagonist and a long-acting selective beta₂-adrenoceptor agonist) that have different effects on clinical and physiological indices.

Glycopyrrolate

Glycopyrrolate is a long-acting antimuscarinic agent which is often referred to as an anticholinergic. It has similar affinity to the subtypes of muscarinic receptors M1 to M5. In the airways, it exhibits pharmacological effects through inhibition of the M3 receptor at the smooth muscle leading to bronchodilation. The competitive and reversible nature of antagonism was shown with human and animal origin receptors and isolated organ preparations. In preclinical *in vitro* as well as *in vivo* studies, prevention of methylcholine and acetylcholine-induced bronchoconstrictive effects was dose-dependent and lasted more than 12 hours. The clinical relevance of these findings is unknown. The bronchodilation following inhalation of glycopyrrolate is predominantly a site-specific effect.

Formoterol Fumarate

Formoterol fumarate is a long-acting selective beta₂-adrenergic agonist (beta₂-agonist) with a rapid onset of action. Inhaled formoterol fumarate acts locally in the lung as a bronchodilator. *In vitro* studies have shown that formoterol has more than 200-fold greater agonist activity at beta₂-receptors than at beta₁-receptors. The *in vitro* binding selectivity to beta₂- over beta₁-adrenoceptors is higher for formoterol than for albuterol (5 times), whereas salmeterol has a higher (3 times) beta₂-selectivity ratio than formoterol.

Although beta₂-receptors are the predominant adrenergic receptors in bronchial smooth muscle and beta₁-receptors are the predominant receptors in the heart, there are also beta₂-receptors in the human heart comprising 10% to 50% of the total beta-adrenergic receptors. The precise function of these receptors has not been established, but they raise the possibility that even highly selective beta₂-agonists may have cardiac effects.

The pharmacologic effects of beta₂-adrenoceptor agonist drugs, including formoterol fumarate, are at least in part attributable to stimulation of intracellular adenylyl cyclase, the enzyme that catalyzes the conversion of adenosine triphosphate (ATP) to cyclic-3', 5'-adenosine monophosphate (cyclic AMP). Increased cyclic AMP levels cause relaxation of bronchial smooth muscle and inhibition of release of mediators of immediate hypersensitivity from cells, especially from mast cells.

In vitro tests show that formoterol fumarate is an inhibitor of the release of mast cell mediators, such as histamine and leukotrienes, from the human lung. Formoterol fumarate also inhibits histamine-induced plasma albumin extravasation in anesthetized guinea pigs and

inhibits allergen-induced eosinophil influx in dogs with airway hyper-responsiveness. The relevance of these *in vitro* and animal findings to humans is unknown.

12.2. Pharmacodynamics

Cardiovascular effects: Healthy Subjects

The potential for QTc interval prolongation was assessed in a double-blind, single-dose, placebo- and positive-controlled crossover trial in 69 healthy subjects. The largest mean (90% upper confidence bound) differences from placebo in baseline-corrected QTcI for 2 inhalations of BEVESPI AEROSPHERE and glycopyrrolate/formoterol fumarate 72/19.2 mcg, were 3.1 (4.7) ms and 7.6 (9.2) ms, respectively, and excluded the clinically relevant threshold of 10 ms.

A dose-dependent increase in heart rate was also observed. The largest mean (90% upper confidence bound) differences from placebo in baseline-corrected heart rate were 3.3 (4.9) beats/min and 7.6 (9.5) beats/min seen within 10 minutes of dosing with 2 inhalations of BEVESPI AEROSPHERE and glycopyrrolate/formoterol fumarate 72/19.2 mcg, respectively.

Chronic Obstructive Pulmonary Disease

The effect of glycopyrrolate/formoterol fumarate on cardiac rhythm in subjects with COPD was assessed using 24-hour Holter monitoring in 2-week and 24-week trials. All treatments were administered as two inhalations twice daily. In the 2-week trial, the Holter monitoring population included 58 subjects on glycopyrrolate/formoterol fumarate 18/4.8 mcg, 58 subjects on glycopyrrolate 18 mcg, and 60 subjects on formoterol fumarate 4.8 mcg. In the 24-week trial, the Holter monitoring population included 171 subjects on BEVESPI AEROSPHERE, 160 subjects on glycopyrrolate 9 mcg, 174 subjects on formoterol fumarate 4.8 mcg, and 80 subjects on placebo. No clinically meaningful effects on cardiac rhythm were observed.

12.3. Pharmacokinetics

Linear pharmacokinetics were observed for glycopyrrolate (dose range: 18 to 144 mcg) and formoterol fumarate (dose range: 2.4 to 19.2 mcg) after oral inhalation.

Absorption

Glycopyrrolate: Following inhaled administration of BEVESPI AEROSPHERE in subjects with COPD, C_{max} occurred at 5 minutes. Steady state is expected to be achieved within 2-3 days of repeated dosing of BEVESPI AEROSPHERE and the extent of exposure is approximately 2.3 times higher than after the first dose.

Formoterol Fumarate: Following inhaled administration of BEVESPI AEROSPHERE in subjects with COPD, C_{max} occurred within 20 to 60 minutes. Steady state is expected to be achieved within 2-3 days of repeated dosing with BEVESPI AEROSPHERE and the extent of exposure is approximately 1.5 times higher than after the first dose.

Distribution

Glycopyrrolate: Population pharmacokinetic analysis showed that estimated Vc/F (volume of the central compartment), and V2/F (volume of the peripheral compartment) are 951 L, and 2019 L, respectively.

Formoterol Fumarate: Population pharmacokinetic analysis showed that estimated Vc/F (volume of the central compartment), and V2/F (volume of the peripheral compartment) are 948 L, and 434 L, respectively. Over the concentration range of 10-500 nmol/L, plasma protein binding of formoterol ranged from 46% to 58%.

Metabolism

Glycopyrrolate: Based on information from the published literature, metabolism plays a minor role in the overall elimination of glycopyrrolate.

Formoterol Fumarate: The primary metabolism of formoterol is by direct glucuronidation and by O-demethylation followed by conjugation to inactive metabolites. Secondary metabolic pathways include deformylation and sulfate conjugation. CYP2D6 and CYP2C have been identified as being primarily responsible for O-demethylation.

Elimination

Glycopyrrolate: After IV administration of a 0.2 mg radiolabeled glycopyrrolate, 85% of dose recovered was recovered in urine 48 hours post dose and some of radioactivity was also recovered in bile. The terminal elimination half-life derived via population pharmacokinetics analysis was 11.8 hours.

Formoterol Fumarate: The excretion of formoterol was studied in four healthy subjects following simultaneous administration of radiolabeled formoterol via the oral and IV routes. In that study, 62% of the radiolabeled formoterol was excreted in the urine while 24% was eliminated in the feces. The terminal elimination half-life derived via population pharmacokinetics analysis was 11.8 hours.

Special Populations

Effect of age, sex, race/ethnicity, or body weight:

Population pharmacokinetic analysis showed no evidence of a clinically significant effect of age, sex, race/ethnicity, or body weight on the pharmacokinetics of glycopyrrolate and formoterol.

Hepatic Impairment: Dedicated studies evaluating effect of hepatic impairment on the pharmacokinetics of glycopyrrolate and formoterol were not conducted.

Renal Impairment: Dedicated studies evaluating effect of renal impairment on the pharmacokinetics of glycopyrrolate and formoterol were not conducted. When glycopyrrolate was administered IV in uremic patients undergoing renal transplantation, mean elimination half-life was significantly longer (46.8 minutes) than in healthy patients (18.6 minutes). The mean AUC (10.6 hr- μ g/L), mean plasma clearance (0.43 L/hr/kg), and mean 3-hour urine excretion (0.7%) for glycopyrrolate were also significantly different than those of controls (3.73 hr- μ g/L, 1.14 L/hr/kg, and 50%, respectively). A population pharmacokinetic analysis using BEVESPI AEROSPHERE showed that formoterol systemic exposure (AUC₀₋₁₂) in subjects with COPD with moderate renal impairment (45 mL/min creatinine clearance) is

expected to be approximately 45% higher compared to subjects with COPD with normal renal function (94 mL/min creatinine clearance).

Drug Interactions

No pharmacokinetic interaction is expected when glycopyrrolate and formoterol fumarate are administered in combination by the inhaled route. Specific drug-drug interaction studies have not been performed with glycopyrrolate or formoterol fumarate.

13 NONCLINICAL TOXICOLOGY

13.1. Carcinogenesis, Mutagenesis, Impairment of Fertility

BEVESPI AEROSPHERE: Long-term studies in animals have not been performed to evaluate the carcinogenic potential of BEVESPI AEROSPHERE which contains glycopyrrolate and formoterol fumarate. The data described below for the individual components apply to BEVESPI AEROSPHERE.

Glycopyrrolate

Long-term studies in animals have not been performed to evaluate the carcinogenic potential of inhaled glycopyrrolate or any other formulations of glycopyrrolate.

Glycopyrrolate was not mutagenic in the bacterial reverse mutation assay, the *in vitro* mammalian cell micronucleus assay in TK6 cells or the *in vivo* micronucleus assay in rats.

In reproduction studies in rats, dietary administration of glycopyrrolate resulted in diminished rates of conception in a dose-related manner. Other studies in dogs suggest that this may be due to diminished seminal secretion which is evident at high doses of glycopyrrolate.

Formoterol Fumarate

Long-term studies were conducted in mice using oral administration and rats using inhalation administration to evaluate the carcinogenic potential of formoterol fumarate.

In a 24-month carcinogenicity study in CD-1 mice, formoterol fumarate at oral doses of 0.1 mg/kg and above [approximately 25 times the maximum recommended human daily inhalation dose (MRHDID) on a mg/m² basis] caused a dose-related increase in the incidence of uterine leiomyomas.

In a 24-month carcinogenicity study in Sprague-Dawley rats, an increased incidence of mesovarian leiomyoma and uterine leiomyosarcoma were observed at the inhaled dose of 130 mcg/kg (approximately 65 times the MRHDID on a mcg/m² basis). No tumors were seen at 22 mcg/kg (approximately 10 times the MRHDID on a mcg/m² basis).

Other beta-agonist drugs have similarly demonstrated increases in leiomyomas of the genital tract in female rodents. The relevance of these findings to human use is unknown.

Formoterol fumarate was not mutagenic or clastogenic in Ames *Salmonella*/microsome plate test, mouse lymphoma test, chromosome aberration test in human lymphocytes, and rat micronucleus test.

A reduction in fertility and/or reproductive performance was identified in male rats treated with formoterol at an oral dose of 15 mg/kg (approximately 7600 times the MRHDID on a mg/m² basis). In a separate study with male rats treated with an oral dose of 15 mg/kg (approximately 7600 times the MRHDID on a mg/m² basis), there were findings of testicular tubular atrophy and spermatid debris in the testes and oligospermia in the epididymides. No such effect was seen at 3 mg/kg (approximately 1500 times the MRHDID on a mg/m² basis). No effect on fertility was detected in female rats at doses up to 15 mg/kg (approximately 7600 times the MRHDID on a mg/m² basis).

14 CLINICAL STUDIES

The safety and efficacy of BEVESPI AEROSPHERE was evaluated in a clinical development program that included 8 dose-ranging trials and two placebo-controlled lung function trials of 24-weeks duration that included a 28-week extension study to evaluate safety over 1 year. The efficacy of BEVESPI AEROSPHERE is based on the dose ranging trials in 822 subjects with COPD and the 2 placebo-controlled confirmatory trials in 3,705 subjects with COPD.

14.1. Dose-Ranging Trials

Dose selection for BEVESPI AEROSPHERE for COPD was primarily based on data for the individual components, glycopyrrolate and formoterol fumarate, in COPD patients. Based on the findings from these studies, glycopyrrolate/formoterol fumarate 18/9.6 mcg administered twice-daily was evaluated in the confirmatory COPD trials.

Glycopyrrolate

Dose selection for glycopyrrolate was supported by a 14-day, randomized, double-blind, placebo-controlled, incomplete-block crossover trial evaluating 6 doses of glycopyrrolate (GP MDI 18 to 0.6 mcg) administered twice daily and an open-label active control in 140 subjects with COPD. A dose ordering was observed, with the glycopyrrolate 18 mcg demonstrating larger improvements in FEV₁ over 12 hours compared with glycopyrrolate 9, 4.6, 2.4, 1.2, and 0.6 mcg (Figure 1).

Figure 1 - Mean Change from Baseline in FEV₁ over Time on Day 14 (MITT Population)

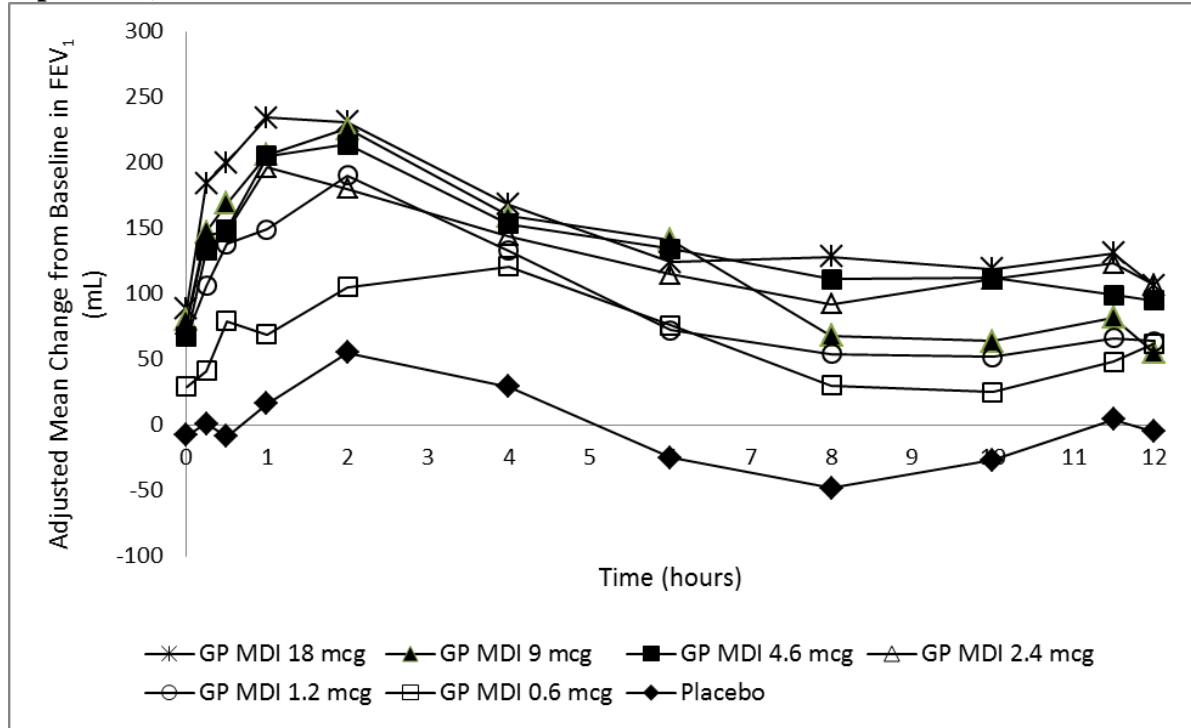

The difference from placebo in change from baseline in trough FEV₁ after 14 days for the 18, 9, 4.6, 2.4, 1.2, and 0.6 mcg doses were 97 mL (95% CI: 45, 149), 88 mL (95% CI: 37, 139), 75 mL (95% CI: 24, 125), 84 mL (95% CI: 33, 135), 76 mL (95% CI: 22, 129), and 37 mL (95% CI: -17, 91), respectively. Two additional dose ranging trials (single-dose and 7-day trials) in subjects with COPD demonstrated minimal additional benefit at doses above 18 mcg of glycopyrrolate. The results supported the selection of 18 mcg of glycopyrrolate twice daily in the confirmatory COPD trials.

Evaluations of the appropriate dosing interval for glycopyrrolate were conducted by comparing to open-label ipratropium bromide inhalation aerosol administered four times daily. The results supported the selection of a twice-daily dosing interval for further evaluation in the confirmatory COPD trials.

Formoterol Fumarate

Dose selection for formoterol fumarate was supported by a single-dose, randomized, double-blind, placebo-controlled, crossover trial evaluating 3 doses of formoterol fumarate (FF MDI 9.6, 4.8 and 2.4 mcg), an open-label active control, and placebo in 34 subjects with COPD. A dose ordering was observed with the formoterol fumarate 9.6 mcg dose demonstrating larger improvements in FEV₁ over 12 hours compared with the lower doses of 4.8 and 2.4 mcg (Figure 2).

Figure 2 - Mean Change from Baseline in FEV₁ over Time on Day 1

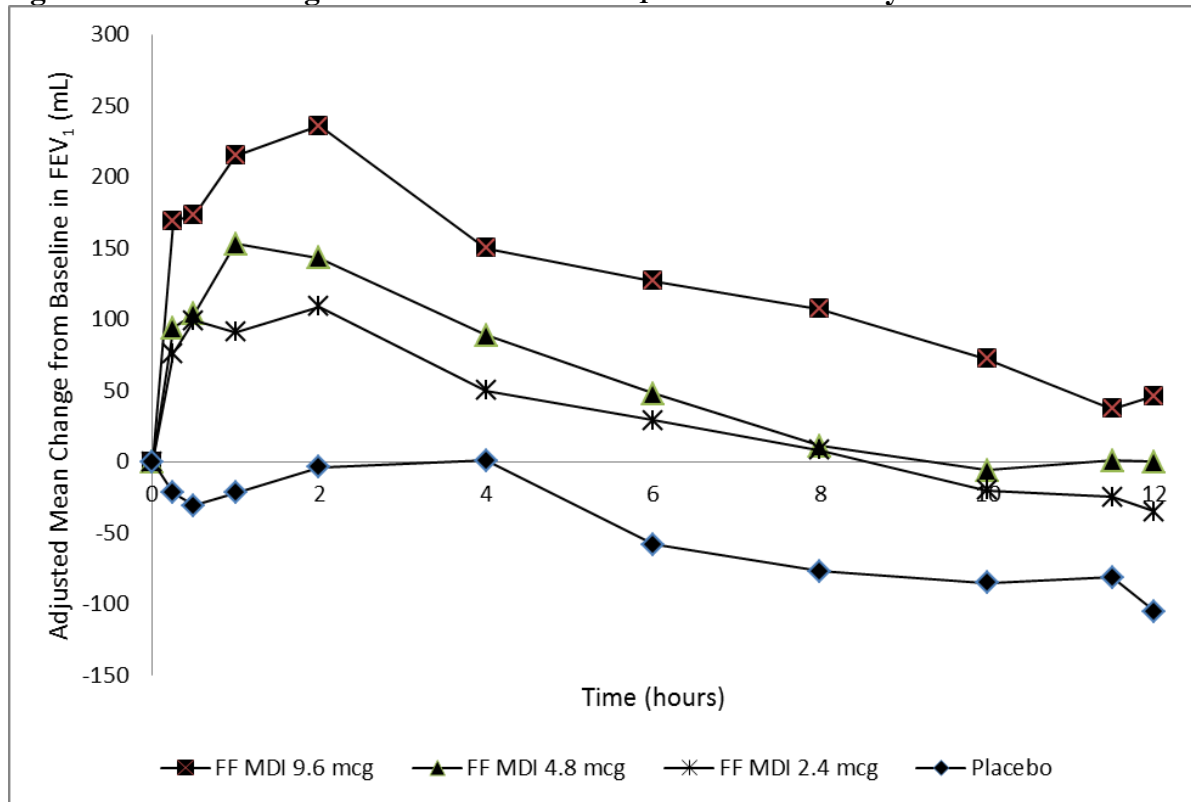

The differences in mean change from baseline in normalized FEV₁ AUC₀₋₁₂ for formoterol fumarate 9.6, 4.8, and 2.4 mcg compared to placebo were 176 mL (95% CI: 138, 214), 103 (95% CI: 66, 140), and 81 (95% CI: 45, 118), respectively. These results provided support for the selection of 9.6 mcg of formoterol fumarate twice daily in the confirmatory COPD trials.

14.2. Confirmatory Trials

The clinical development program for BEVESPI AEROSPHERE included two (Trial 1 and Trial 2) 24-week, randomized, double-blind, placebo-controlled, parallel-group trials in subjects with moderate to very severe COPD designed to evaluate the efficacy of BEVESPI AEROSPHERE on lung function. The 24-week trials included 3,699 subjects that had a clinical diagnosis of COPD, were between 40 and 80 years of age, had a history of smoking greater than or equal to 10 pack-years, had a post-albuterol FEV₁ less than 80% of predicted normal values, and had a ratio of FEV₁/FVC of less than 0.7. The majority of patients were male (56%) and Caucasian (91%) with a mean age of 63 years and an average smoking history of 51 pack-years (54% current smokers). During screening, mean post-bronchodilator percent predicted FEV₁ was 51% (range: 19% to 82%) and mean percent reversibility was 20% (range: -32% to 135%).

Trial 1 and Trial 2 evaluated BEVESPI AEROSPHERE (glycopyrrolate/formoterol fumarate) 18 mcg/9.6 mcg, glycopyrrolate 18 mcg, formoterol fumarate 9.6 mcg, and placebo administered twice daily (BID). Trial 1 also included an open-label active control.

The primary endpoint was change from baseline in trough FEV₁ at Week 24 compared with placebo, glycopyrrolate 18 mcg BID, and formoterol fumarate 9.6 mcg BID. The comparison of BEVESPI AEROSPHERE with glycopyrrolate 18 mcg and formoterol fumarate 9.6 mcg was assessed to evaluate the contribution of the individual components to BEVESPI AEROSPHERE. In both trials, BEVESPI AEROSPHERE demonstrated a larger increase in mean change from baseline in trough FEV₁ at Week 24 relative to placebo, glycopyrrolate 18 mcg, and formoterol fumarate 9.6 mcg (Table 2).

Table 2 – Least Square (LS) Mean Change from Baseline in Morning Pre-dose Trough FEV₁ (mL) at Week 24 in Trial 1 and Trial 2 (Intent-to-Treat Population)

Treatment	N	Trough FEV ₁ (mL) at Week 24		
		Difference from		
		Placebo* LS Mean (95% CI)	Glycopyrrolate 18 mcg BID* LS Mean (95% CI)	Formoterol Fumarate 9.6 mcg BID* LS Mean (95% CI)
Trial 1				
BEVESPI AEROSPHERE	429	N=161 150 mL (114, 186)	N=344 59 mL (31, 88)	N=367 64 mL (36, 92)
Trial 2				
BEVESPI AEROSPHERE	433	N=170 103 mL (67, 140)	N=367 54 mL (25, 83)	N=350 56 mL (27, 85)

N = Number in the intent to treat population

*The placebo, glycopyrrolate and formoterol fumarate comparators used the same inhaler and excipients as BEVESPI AEROSPHERE.

With the limited data available, there were consistent improvements in trough FEV₁ with respect to age, sex, degree of airflow limitation, GOLD stage, smoking status, or inhaled corticosteroid use.

In Trials 1 and 2, serial spirometric evaluations were performed throughout the 12-hour dosing interval in a subset of subjects (n=718 and n=585, respectively) at Day 1 and Week 12. Results from Trial 1 are shown in Figure 3. In Trial 2, the results for BEVESPI AEROSPHERE in FEV₁ AUC_{0-12h} were similar to those observed in Trial 1.

Figure 3 - Mean Change from Baseline in FEV₁ over Time at Day 1 and Week 12 (Trial 1)

Day 1

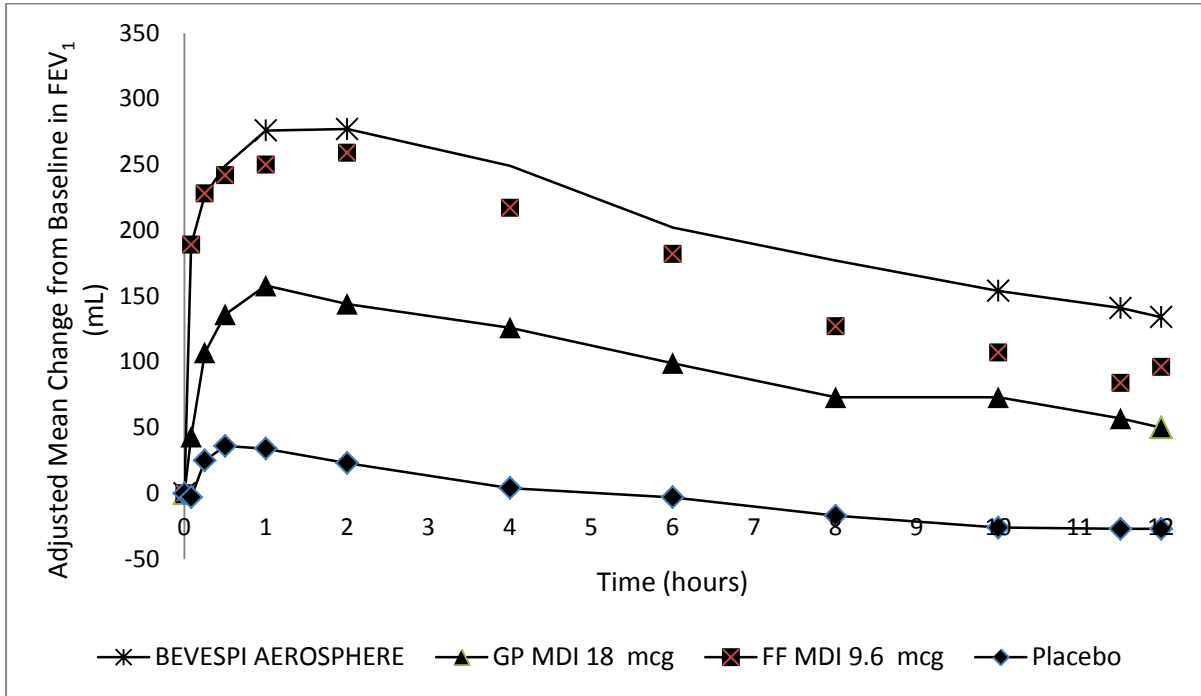

Week 12

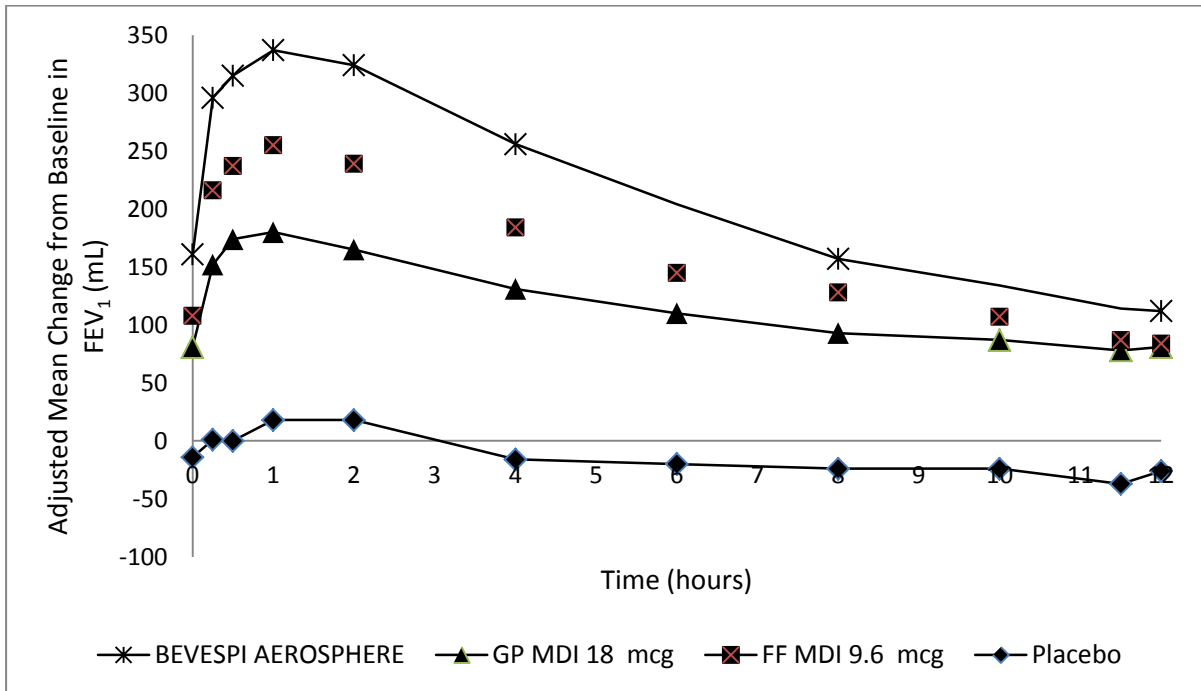

In both trials, peak FEV₁ was defined as the maximum FEV₁ recorded within 2 hours after the dose of trial medication. The mean peak FEV₁ improvement from baseline with BEVESPI AEROSPHERE compared with placebo at Week 24 was 291 mL (95% CI: 252, 331) and 267 mL (95% CI: 226, 308) in Trial 1 and Trial 2, respectively. BEVESPI AEROSPHERE demonstrated an onset of bronchodilatory treatment effect at 5 minutes after the first dose based on a mean increase in FEV₁ compared to placebo of 187 mL (95% CI: 168, 205) and 186 mL (95% CI: 164, 207) in Trial 1 and Trial 2, respectively. In both Trial 1 and 2, subjects treated with BEVESPI AEROSPHERE used less daily rescue albuterol compared to subjects treated with placebo.

The St. George's Respiratory Questionnaire (SGRQ) was assessed in Trials 1 and 2. In Trial 1, the SGRQ responder rate (defined as an improvement in score of 4 or more as threshold) was 37%, 30%, 35%, and 28% for BEVESPI AEROSPHERE, glycopyrrolate, formoterol fumarate, and placebo, respectively, with odds ratios of 1.4 (95% CI: 1.1, 1.8), 1.1 (95% CI: 0.9, 1.5), and 1.5 (95% CI: 1.1, 2.1), for BEVESPI AEROSPHERE vs. glycopyrrolate, BEVESPI AEROSPHERE vs. formoterol fumarate, and BEVESPI AEROSPHERE vs. placebo, respectively. In Trial 2, the trends were similar, with odds ratios of 1.2 (95% CI: 0.9, 1.6), 1.3 (95% CI: 1.0, 1.7), and 1.3 (95% CI: 0.9, 1.8), for BEVESPI AEROSPHERE vs. glycopyrrolate, BEVESPI AEROSPHERE vs. formoterol fumarate, and BEVESPI AEROSPHERE vs. placebo, respectively.

16 HOW SUPPLIED/STORAGE AND HANDLING

BEVESPI AEROSPHERE Inhalation Aerosol is supplied as a pressurized aluminum canister with an attached dose indicator, a white plastic actuator and mouthpiece, and an orange dust cap. Each 120 inhalation canister has a net fill weight of 10.7 grams. Each canister is packaged in a foil pouch with desiccant sachet and is placed into a carton. Each carton contains one canister and a Medication Guide (NDC 0310-4600-12).

The BEVESPI AEROSPHERE canister should only be used with the BEVESPI AEROSPHERE actuator, and the BEVESPI AEROSPHERE actuator should not be used with any other inhalation drug product.

The correct amount of medication in each inhalation cannot be assured after the label number of inhalations from the canister have been used, when the dose indicator display window shows zero, even though the canister may not feel completely empty. BEVESPI AEROSPHERE should be discarded when the dose indicator display window shows zero or 3 months after removal from the foil pouch, whichever comes first. Never immerse the canister into water to determine the amount remaining in the canister ("float test").

Store at controlled room temperature 20° to 25°C (68° to 77°F); excursions permitted to 15° to 30°C (59° to 86°F) [see USP].

For best results, the canister should be at room temperature before use. Shake well before using. Keep out of reach of children.

CONTENTS UNDER PRESSURE

Do not puncture. Do not use or store near heat or open flame. Exposure to temperatures above 49°C (120°F) may cause bursting. Never throw canister into fire or incinerator. Avoid spraying in eyes.

17 PATIENT COUNSELING INFORMATION

Advise the patient to read the FDA-approved patient labeling (Medication Guide and Instructions for Use)

Asthma-Related Death: Inform patients that LABAs, such as formoterol fumarate, one of the active ingredients in BEVESPI AEROSPHERE, increase the risk of asthma-related death. BEVESPI AEROSPHERE is not indicated for the treatment of asthma.

Not for Acute Symptoms: Inform patients that BEVESPI AEROSPHERE is not meant to relieve acute symptoms of COPD and extra doses should not be used for that purpose. Advise them to treat acute symptoms with a rescue inhaler such as albuterol. Provide patients with such medicine and instruct them in how it should be used.

Instruct patients to seek medical attention immediately if they experience any of the following:

- Symptoms get worse
- Need for more inhalations than usual of their rescue inhaler

Patients should not stop therapy with BEVESPI AEROSPHERE without physician/provider guidance since symptoms may recur after discontinuation.

Do Not Use Additional Long-Acting Beta₂-Agonists: Instruct patients to not use other medicines containing a LABA. Patients should not use more than the recommended dose of BEVESPI AEROSPHERE.

Instruct patients who have been taking inhaled, short-acting beta₂-agonists on a regular basis to discontinue the regular use of these products and use them only for the symptomatic relief of acute symptoms.

Paradoxical Bronchospasm: As with other inhaled medicines, BEVESPI AEROSPHERE can cause paradoxical bronchospasm. If paradoxical bronchospasm occurs, instruct patients to discontinue BEVESPI AEROSPHERE.

Risks Associated With Beta₂-Agonist Therapy: Inform patients of adverse effects associated with beta₂-agonists, such as palpitations, chest pain, rapid heart rate, tremor, or nervousness. Instruct patients to consult a physician immediately should any of these signs or symptoms develop.

Worsening of Narrow Angle Glaucoma: Instruct patients to be alert for signs and symptoms of acute narrow-angle glaucoma (e.g., eye pain or discomfort, blurred vision, visual halos or colored images in association with red eyes from conjunctival congestion and corneal

edema). Instruct patients to consult a physician immediately should any of these signs or symptoms develop.

Worsening of Urinary Retention: Instruct patients to be alert for signs and symptoms of urinary retention (e.g., difficulty passing urine, painful urination). Instruct patients to consult a physician immediately should any of these signs or symptoms develop.

Instructions for Administering BEVESPI AEROSPHERE

It is important for patients to understand how to correctly administer BEVESPI AEROSPHERE [see *Instructions for Use*].

Inform patients to use 2 inhalations of BEVESPI AEROSPHERE orally twice daily (2 inhalations in the morning and 2 inhalations in the evening).

Instruct patients to prime BEVESPI AEROSPHERE before using it for the first time. Instruct patients to prime BEVESPI AEROSPHERE by releasing 4 sprays into the air away from their face, shaking well before each spray. Inform patients that BEVESPI AEROSPHERE must be re-primed when the inhaler has not been used for more than 7 days. Instruct patients to re-prime BEVESPI AEROSPHERE by releasing 2 sprays into the air away from their face, shaking well before each spray.

Inform patients that it is very important to clean BEVESPI AEROSPHERE 1 time each week so that medicine will not build up and block the spray through the mouthpiece [see *Instructions for Use*]. Instruct patients to clean BEVESPI AEROSPHERE by taking the canister out of the actuator, running warm water through the actuator, and allowing the actuator to air-dry overnight. Instruct patients to insert the canister back into the actuator after it is dry, and to re-prime BEVESPI AEROSPHERE. Instruct patients to re-prime BEVESPI AEROSPHERE by releasing 2 sprays into the air away from their face, shaking well before each spray.

Inform patients that if they miss a dose of BEVESPI AEROSPHERE, they should take their next dose at the usual time. Instruct patients to not use BEVESPI AEROSPHERE more often or more puffs than they have been prescribed.

Instruct patients not to spray BEVESPI AEROSPHERE in their eyes. Inform patients that if they accidentally get BEVESPI AEROSPHERE in their eyes, to rinse their eyes with water, and if redness or irritation persists, to consult their healthcare provider.

BEVESPI[®], AEROSPHERE[™] and BEVESPI AEROSPHERE[™] are trademarks of the AstraZeneca group of companies.

©AstraZeneca 2016

Manufactured for: AstraZeneca Pharmaceuticals LP, Wilmington, DE 19850

By: Aventis Pharma LTD, Holmes Chapel CW48BE, United Kingdom

MEDICATION GUIDE
BEVESPI AEROSPHERE™
(be-VES-pee AIR-oh-sfeer)
(glycopyrrolate and formoterol fumarate)
inhalation aerosol, for oral inhalation use

What is the most important information I should know about BEVESPI AEROSPHERE?

BEVESPI AEROSPHERE is only approved for use in chronic obstructive pulmonary disease (COPD). BEVESPI AEROSPHERE is NOT approved for use in asthma.

BEVESPI AEROSPHERE can cause serious side effects, including:

- **People with asthma who take long-acting beta₂adrenergic agonist (LABA) medicines, such as formoterol fumarate (one of the medicines in BEVESPI AEROSPHERE), have an increased risk of death from asthma problems.**
- **It is not known if LABA medicines, such as formoterol fumarate (one of the medicines in BEVESPI AEROSPHERE), increase the risk of death in people with COPD.**
- **Call your healthcare provider if breathing problems worsen over time while using BEVESPI AEROSPHERE.** You may need different treatment.
- **Get emergency medical care if:**
 - your breathing problems worsen quickly
 - you use your rescue inhaler, but it does not relieve your breathing problems

What is BEVESPI AEROSPHERE?

BEVESPI AEROSPHERE combines an anticholinergic, glycopyrrolate, and a LABA medicine, formoterol fumarate.

- Anticholinergic and LABA medicines help the muscles around the airways in your lungs stay relaxed to prevent symptoms such as wheezing, cough, chest tightness, and shortness of breath. These symptoms can happen when the muscles around the airways tighten. This makes it hard to breathe.
- BEVESPI AEROSPHERE is a prescription medicine used to treat COPD. COPD is a chronic lung disease that includes chronic bronchitis, emphysema, or both.
- BEVESPI AEROSPHERE is used long term as 2 inhalations, 2 times each day in the morning and in the evening, to improve symptoms of COPD for better breathing.
- **BEVESPI AEROSPHERE is not for use to treat sudden symptoms of COPD.** Always have a rescue inhaler (an inhaled, short-acting bronchodilator) with you to treat sudden symptoms. If you do not have a rescue inhaler, contact your healthcare provider to have one prescribed for you.
- **BEVESPI AEROSPHERE is not for the treatment of asthma.** It is not known if BEVESPI AEROSPHERE is safe and effective in people with asthma.
- BEVESPI AEROSPHERE should not be used in children. It is not known if BEVESPI AEROSPHERE is safe and effective in children.

Who should not use BEVESPI AEROSPHERE?

Do not use BEVESPI AEROSPHERE if you:

- are allergic to glycopyrrolate, formoterol fumarate, or to any of the ingredients in BEVESPI AEROSPHERE. See **“What are the ingredients in BEVESPI AEROSPHERE?”** below for a complete list of ingredients.
- have asthma. See **“What is the most important information I should know about BEVESPI AEROSPHERE?”**

What should I tell my healthcare provider before using BEVESPI AEROSPHERE?

Before using BEVESPI AEROSPHERE, tell your healthcare provider about all of your medical conditions, including if you:

- have heart problems
- have high blood pressure
- have seizures
- have thyroid problems
- have diabetes
- have liver problems
- have eye problems such as glaucoma. BEVESPI AEROSPHERE may make your glaucoma worse.
- have prostate or bladder problems, or problems passing urine. BEVESPI AEROSPHERE may make these problems worse.
- are allergic to any other medicines or food products
- have any other medical conditions
- are pregnant or planning to become pregnant. It is not known if BEVESPI AEROSPHERE may harm your unborn baby.
- are breastfeeding. It is not known if the medicines in BEVESPI AEROSPHERE pass into your breast milk and if they can harm your baby.

Tell your healthcare provider about all of the medicines you take, including prescription and over-the-counter

medicines, vitamins, and herbal supplements. BEVESPI AEROSPHERE and certain other medicines may interact with each other. This may cause serious side effects.

Especially tell your healthcare provider if you take:

- anticholinergics (including tiotropium, ipratropium, aclidinium, and umeclidinium)
- other LABAs (including salmeterol, arformoterol, vilanterol, olodaterol, and indacaterol)
- atropine

Know the medicines you take. Keep a list of them to show your healthcare provider and pharmacist each time you get a new medicine.

How should I use BEVESPI AEROSPHERE?

Read the step-by-step instructions for using BEVESPI AEROSPHERE at the end of this Medication Guide.

- **Do not** use BEVESPI AEROSPHERE unless your healthcare provider has taught you how to use the inhaler and you understand how to use it correctly.
- Use BEVESPI AEROSPHERE exactly as your healthcare provider tells you to use it. **Do not** use BEVESPI AEROSPHERE more often than prescribed.
- Use 2 inhalations of BEVESPI AEROSPHERE, 2 times each day (in the morning and in the evening).
- If you miss a dose of BEVESPI AEROSPHERE, take your next dose at the same time you normally do. **Do not** take more than your prescribed dose of BEVESPI AEROSPHERE.
- **Do not** spray BEVESPI AEROSPHERE in your eyes. If BEVESPI AEROSPHERE gets in your eyes, rinse them well with water. If redness continues, call your healthcare provider.
- **Do not** stop using BEVESPI AEROSPHERE unless told to do so by your healthcare provider because your symptoms might come back. Your healthcare provider will change your medicines as needed.
- **Do not use other medicines that contain a LABA or an anticholinergic for any reason.** Ask your healthcare provider or pharmacist if any of your other medicines are LABA or anticholinergic containing medicines.
- **BEVESPI AEROSPHERE does not relieve sudden symptoms.** Always have a rescue inhaler with you to treat sudden symptoms. If you do not have a rescue inhaler, call your healthcare provider to have one prescribed for you.
- **Call your healthcare provider or get medical care right away if:**
 - your breathing problems get worse
 - you need to use your rescue inhaler more often than usual
 - your rescue inhaler does not work as well to relieve your symptoms

What are the possible side effects with BEVESPI AEROSPHERE?

BEVESPI AEROSPHERE can cause serious side effects, including:

- **See “What is the most important information I should know about BEVESPI AEROSPHERE?”**
 - **sudden breathing problems immediately after inhaling your medicine**
 - **serious allergic reactions.** Call your healthcare provider or get emergency medical care if you get any of the following symptoms of a serious allergic reaction:
 - rash
 - hives
 - swelling of the face, mouth, and tongue
 - breathing problems
 - **effects on your heart:**
 - increase blood pressure
 - a fast or irregular heartbeat
 - chest pain
 - **effects on your nervous system:**
 - tremor
 - nervousness
 - **new or worsened eye problems including acute narrow-angle glaucoma.** Acute narrow-angle glaucoma can cause permanent loss of vision if not treated. Symptoms of acute narrow-angle glaucoma may include:
 - eye pain or discomfort
 - nausea or vomiting
 - blurred vision
 - seeing halos or bright colors around lights
 - red eyes
- If you have these symptoms, call your healthcare provider right away before taking another dose.

Common side effects of BEVESPI AEROSPHERE include:

- urinary tract infection
- cough

Tell your healthcare provider about any side effect that bothers you or that does not go away.

These are not all the side effects of BEVESPI AEROSPHERE. Ask your healthcare provider or pharmacist for more information.

Call your doctor for medical advice about side effects. You may report side effects to FDA at 1-800-FDA-1088.

You may also report side effects to AstraZeneca at 1-800-236-9933.

How do I store BEVESPI AEROSPHERE?

- Store BEVESPI AEROSPHERE at room temperature between 68°F to 77°F (20°C to 25°C).
- **Do not** put a hole in the BEVESPI AEROSPHERE canister.
- **Do not** use or store BEVESPI AEROSPHERE near heat or a flame. Temperatures above 120°F (49°C) may cause the canister to burst.
- **Do not** throw the BEVESPI AEROSPHERE canister into a fire or an incinerator.
- Throw away BEVESPI AEROSPHERE 3 months after you open the foil pouch or when the dose indicator reaches zero "0", whichever comes first.
- **Keep BEVESPI AEROSPHERE and all medicines out of the reach of children.**

General Information about the safe and effective use of BEVESPI AEROSPHERE

Medicines are sometimes prescribed for purposes other than those listed in a Medication Guide. Do not use BEVESPI AEROSPHERE for a condition for which it was not prescribed. Do not give your BEVESPI AEROSPHERE to other people, even if they have the same condition that you have. It may harm them.

This Medication Guide summarizes the most important information about BEVESPI AEROSPHERE. If you would like more information, talk with your healthcare provider or pharmacist. You can ask your healthcare provider or pharmacist for information about BEVESPI AEROSPHERE that was written for healthcare professionals.

For more information, call 1-800-236-9933 or go to www.BEVESPI.com.

What are the ingredients in BEVESPI AEROSPHERE?

Active ingredients: micronized glycopyrrolate and micronized formoterol fumarate

Inactive ingredients: hydrofluoroalkane (HFA 134a) and porous particles (comprised of DSPC [1,2-Distearoyl-*sn*-glycero-3-phosphocholine] and calcium chloride)

Manufactured for: AstraZeneca Pharmaceuticals LP, Wilmington, DE 19850; Manufactured by: Aventis Pharma LTD, Holmes Chapel CW48BE, United Kingdom

©AstraZeneca 2016

This Medication Guide has been approved by the U.S. Food and Drug Administration

April 2016

Instructions for Use
BEVESPI AEROSPHERE™
(be-VES-pee AIR-oh-sfeer)
(glycopyrrolate and formoterol fumarate)
Inhalation aerosol, for oral inhalation use

Read this Instructions for Use before you start using BEVESPI AEROSPHERE and each time you get a refill. There may be new information. This information does not take the place of talking to your healthcare provider about your medical condition or treatment.

Important Information:

- **For oral inhalation use only.**
- Use BEVESPI AEROSPHERE exactly as your healthcare provider tells you to.
- If you have any questions about the use of your inhaler, ask your healthcare provider or pharmacist.

Parts of your BEVESPI AEROSPHERE inhaler (See Figure 1):

- BEVESPI AEROSPHERE comes as a canister that fits into an actuator with a dose indicator.
 - **Do not** use the BEVESPI AEROSPHERE actuator with a canister of medicine from any other inhaler.
 - **Do not** use the BEVESPI AEROSPHERE canister with an actuator from any other inhaler.

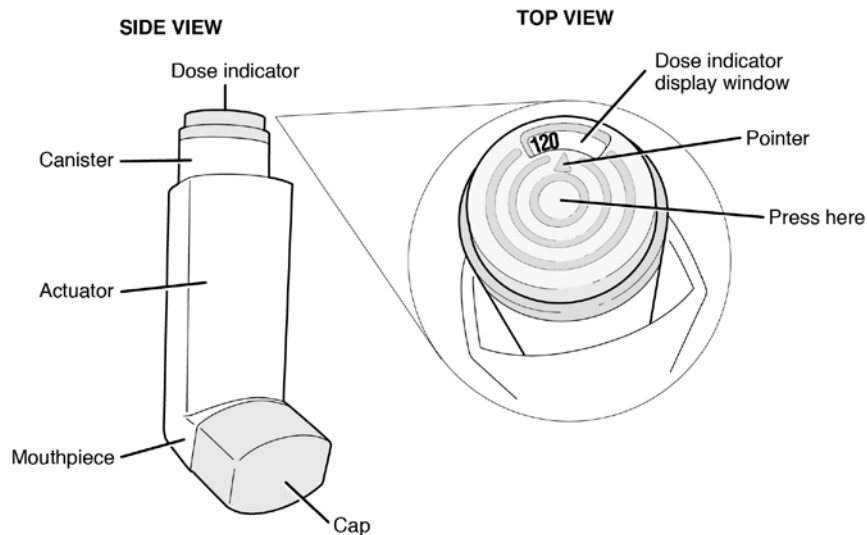

Figure 1

- BEVESPI AEROSPHERE comes with a dose indicator located on the top of the canister (**See Figure 1**). The dose indicator display window will show you how many puffs of medicine you have left. A puff of medicine is released each time you press the center of the dose indicator.

Before you use BEVESPI AEROSPHERE for the first time make sure that the pointer on the dose indicator is pointing to the right of the “120” inhalation mark in the dose indicator display window (**See Figure 1**).

- The pointer will be pointing to 120 after 10 puffs are delivered from BEVESPI AEROSPHERE. This means that there are 120 puffs of medicine left in the canister (**See Figure 2a**).
- The pointer will be pointing between 100 and 120 after you take 10 more puffs. This means that there are 110 puffs of medicine left in the canister (**See Figure 2b**).
- The pointer will be pointing to 100 after you take 10 more puffs. This means that there are 100 puffs of medicine left in the canister (**See Figure 2c**).

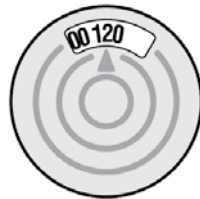

Figure 2a
120 puffs



Figure 2b
110 puffs



Figure 2c
100 puffs

- The dose indicator display window will continue to move after every 10 puffs. The number in the dose indicator display window will continue to change after every 20 puffs.

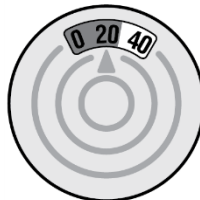

Figure 2d

- The color in the dose indicator display window will change to red, as shown in the shaded area, when there are only 20 puffs of medicine left in your inhaler (**See Figure 2d**).

Preparing your BEVESPI AEROSPHERE inhaler for use:

- BEVESPI AEROSPHERE should be at room temperature before you use it.
- Your BEVESPI AEROSPHERE inhaler comes in a foil pouch that contains a drying packet (desiccant).
 - Take the BEVESPI AEROSPHERE inhaler out of the foil pouch.
 - Throw away the pouch and the drying packet. Do not eat or breathe in the contents of the drying packet.

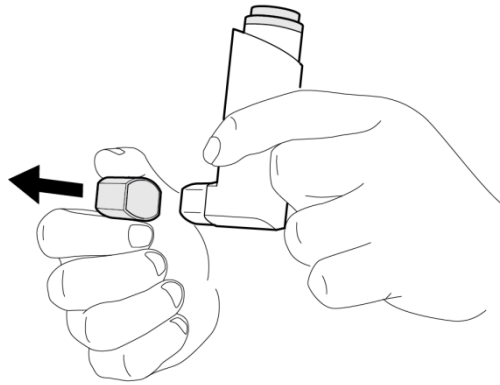

Figure 3

Priming your BEVESPI AEROSPHERE inhaler:

Before you use BEVESPI AEROSPHERE for the first time, you must prime the inhaler.

- Remove the cap from the mouthpiece (**See Figure 3**). Check inside the mouthpiece for objects before use.
- Hold the inhaler in the upright position away from your face and shake the inhaler well (**See Figure 4**).

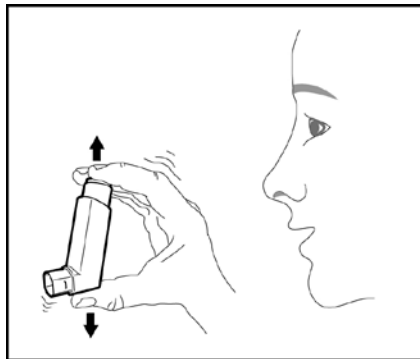

Figure 4

- Press down firmly on the center of the dose indicator until the canister stops moving in the actuator, to release a puff of medicine from the mouthpiece (**See Figure 5**). You may hear a soft click from the dose indicator as it counts down during use.

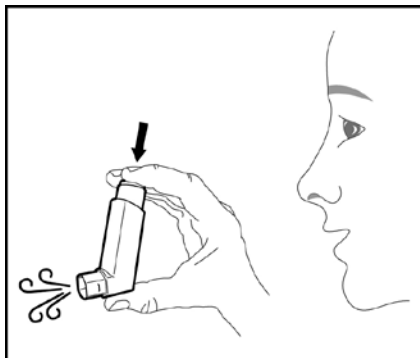

Figure 5

- **Repeat the priming steps 3 more times (See Figure 4 and Figure 5).** Shake the inhaler well before each priming puff.
- After priming 4 times, the dose indicator should be pointing to the right of “120” and your inhaler is now ready to use.

Using your BEVESPI AEROSPHERE inhaler:

Step 1: Remove the cap from the mouthpiece (See Figure 6).

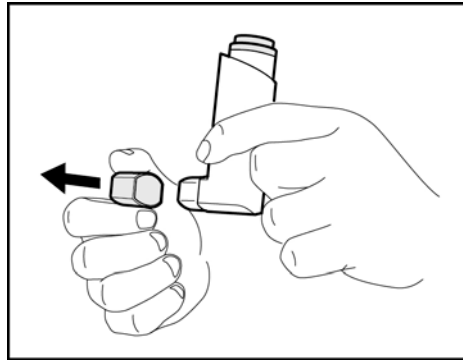

Figure 6

Step 2: Shake the inhaler well before each use (See Figure 7).

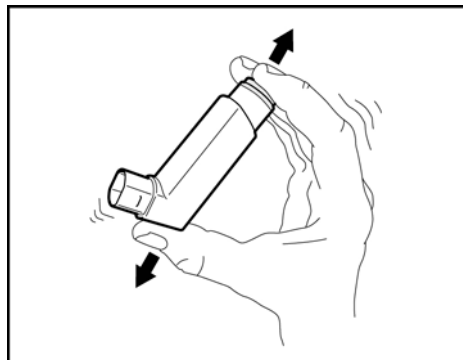

Figure 7

Step 3: Hold the inhaler with the mouthpiece pointing towards you and breathe out as fully as you comfortably can through your mouth (See Figure 8).

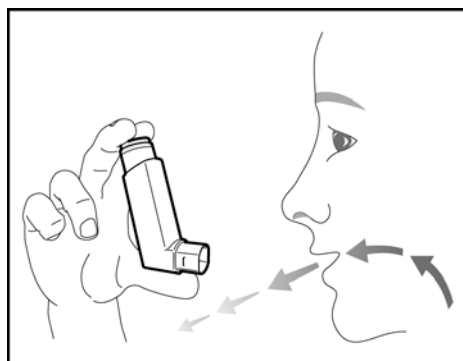

Figure 8

Step 4: Close your lips around the mouthpiece and tilt your head back, keeping your tongue below the mouthpiece (**See Figure 9**).

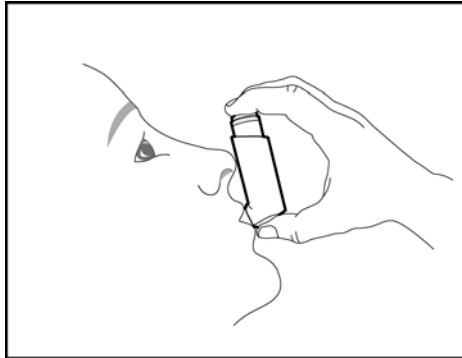

Figure 9

Step 5: While breathing in deeply and slowly, press down on the center of the dose indicator until the canister stops moving in the actuator and a puff of medicine has been released (**See Figure 10**). Then stop pressing the dose indicator.

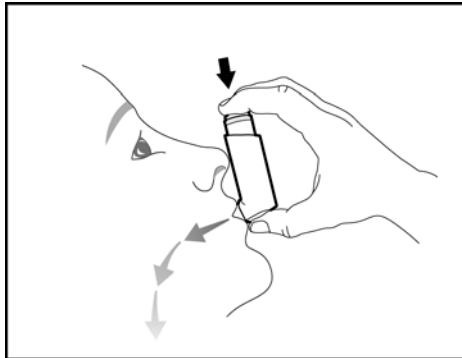

Figure 10

Step 6: When you have finished breathing in, remove the mouthpiece from your mouth. Hold your breath as long as you comfortably can, up to 10 seconds (**See Figure 11**).

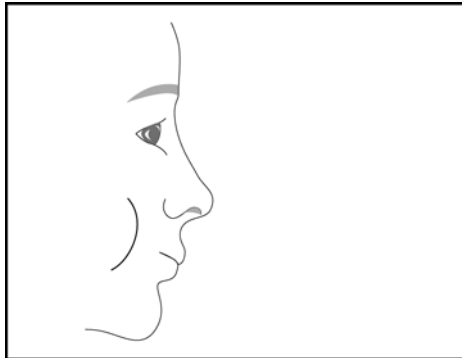

Figure 11

Step 7: Breathe out gently (**See Figure 12**). Repeat steps 2 through 7 to take your second puff of BEVESPI AEROSPHERE.

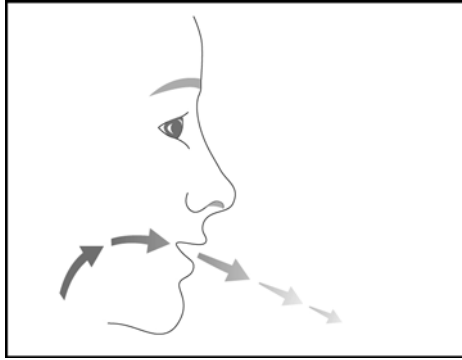

Figure 12

Step 8: Replace the cap over the mouthpiece right away after use (See Figure 13).

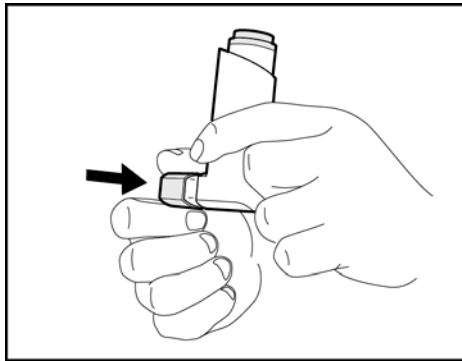

Figure 13

How to clean your BEVESPI AEROSPHERE inhaler:

Clean the inhaler 1 time each week. It is very important to keep your inhaler clean so that medicine will not build-up and block the spray through the mouthpiece (See Figure 14).

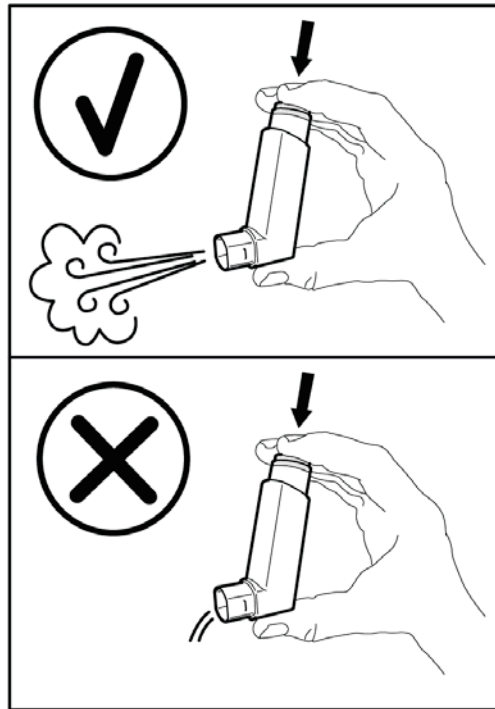

Figure 14

Step 1: Take the canister out of the actuator (See Figure 15). **Do not** clean the canister or let it get wet.

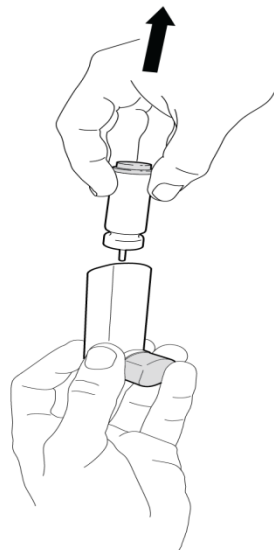

Figure 15

Step 2: Take the cap off the mouthpiece.

Step 3: Hold the actuator under the faucet and run warm water through it for about 30 seconds. Turn the actuator upside down and rinse the actuator again through the mouthpiece for about 30 seconds (**See Figure 16**).

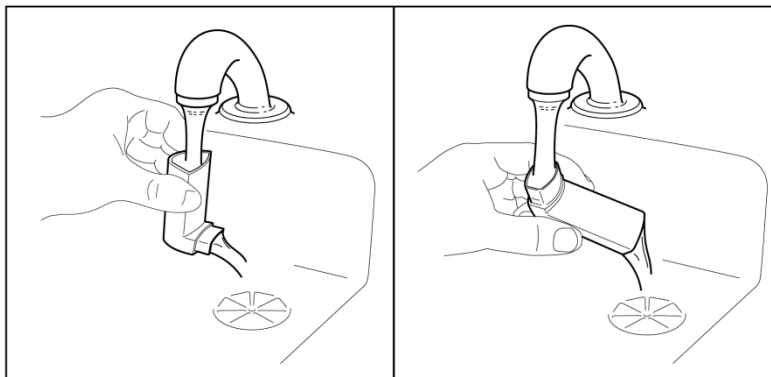

Figure 16

Step 4: Shake off as much water from the actuator as you can.

Step 5: Look into the actuator and the mouthpiece to make sure any medicine build-up has been completely washed away. If there is any build-up, repeat Steps 3 through 5 in the section “**How to clean your BEVESPI AEROSPHERE inhaler**”.

Step 6: Let the actuator air-dry overnight (**See Figure 17**). **Do not** put the canister back into the actuator if it is still wet.

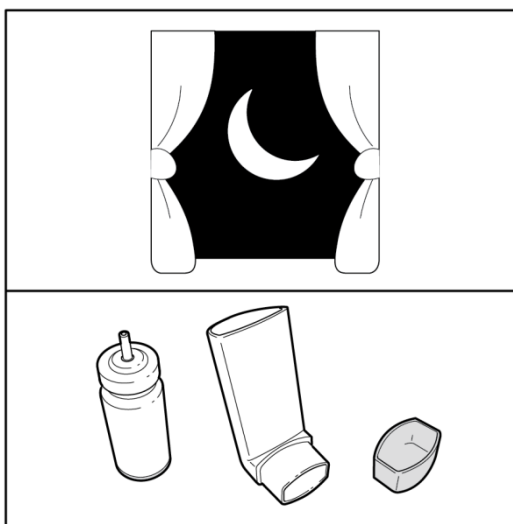

Figure 17

Step 7: When the actuator is dry, gently press the canister down in the actuator (**See Figure 18**). Do not press down too hard on the canister. This could cause a puff of medicine to be released.

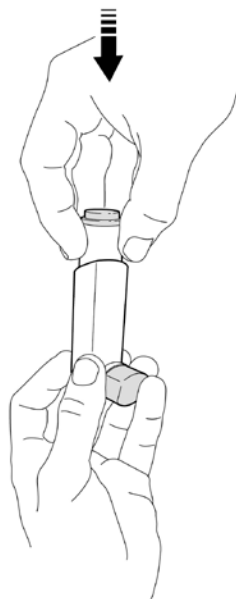

Figure 18

Step 8: Re-prime your **BEVESPI AEROSPHERE** inhaler after each cleaning. To re-prime the inhaler, shake the inhaler well and press down on the center of the dose indicator 2 times to release a total of 2 puffs into the air away from your face. Your inhaler is now ready to use.

If you do not use your BEVESPI AEROSPHERE for more than 7 days, you will need to re-prime it before use.

To re-prime the inhaler, shake the inhaler well and press down on the center of the dose indicator 2 times to release a total of 2 puffs into the air away from your face. Your inhaler is now ready to use.

BEVESPI and BEVESPI AEROSPHERE are trademarks of the AstraZeneca group of companies.

©AstraZeneca 2016

Manufactured for: AstraZeneca Pharmaceuticals LP, Wilmington, DE 19850

By: Aventis Pharma LTD, Holmes Chapel CW48BE, United Kingdom

This Instructions for Use has been approved by the U.S. Food and Drug Administration.

Revised: April 2016